

DATE:

PROJECT:

COMMENTS:

PARmate®
Outdoor Lighting Fixture



CONSTRUCTION

- Corrosion-free, high impact polycarbonate housing
- Silicone seal permits lamps to be positioned vertically
- EDPM cover plate gasket
- Porcelain medium screw base lamp holder
- Brass screws and inserts

LAMP

- PAR 38 and PAR 20 lamps (Lamp not included)
- 150W maximum

MOUNTING

- Wall, ceiling, and ground

FINISH

- Bright arctic white
- Architectural gray
- Forest green
- Midnight black

APPROVALS

- DLC (Lamp dependent)
- ETL
- CSA Certified
- Made in the USA
- Indoor/outdoor
- Suitable for wet locations
- Materials meet UL 94-5V standards for flame retardant
- Marine grade.

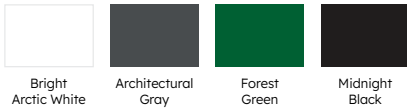

ORDERING LOGIC

PARmate®-65-1-1-0

SERIES	LAMP HOLDERS	FINISH	WEATHERPROOF BOX	OPTIONS
PARmate®-65	1 One Lamp Holder 2 Two Lamp Holders 3 Three Lamp Holders	1 Bright Arctic White 2 Architectural Gray 3 Forest Green 4 Midnight Black	0 No Box 1 Matching Weatherproof Box	20 PAR 20 Shroud 38 PAR 38 Shroud MS Motion Sensor GMS Ground Mount Stake
PARmat®-65				

DIMENSIONS

Front

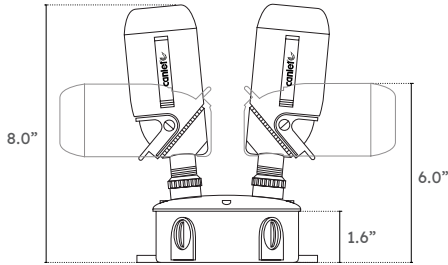

Side

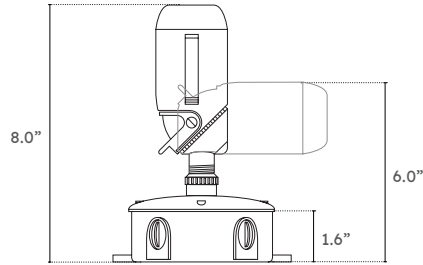

Base

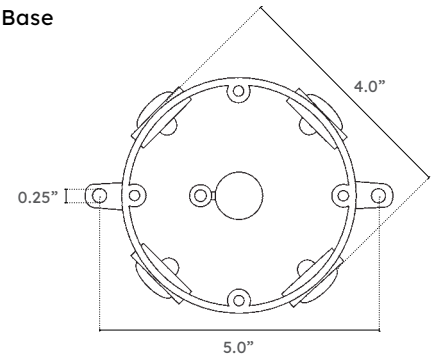

INSTALLATION

Both the single hole and three hole covers fit on all 4" weatherproof boxes, recessed 4" octagonal boxes and matching Canlet weatherproof boxes. Screw caps are provided to plug unused mounting holes. The matching weatherproof box has five 1/2" threaded hubs and four plugs. The rear hub is a knockout. The box's mounting feet are spaced 5". Each fixture comes with installation aiming instructions.

DRAWINGS

One Lamp Holder with Cover

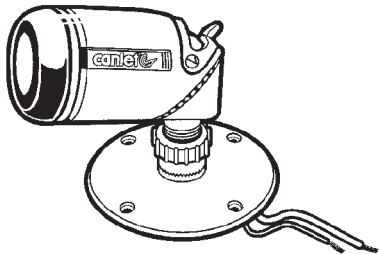

Two Lamp Holders with Cover

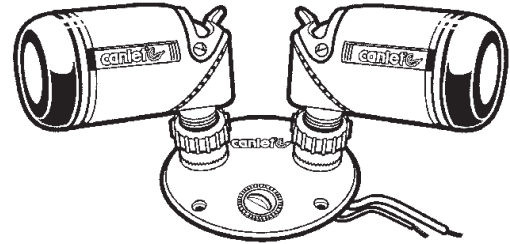

One Lamp Holder with Cover and Box

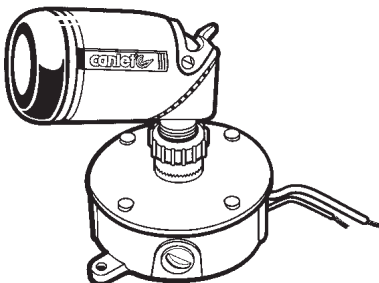

Two Lamp Holders with Cover and Box

